

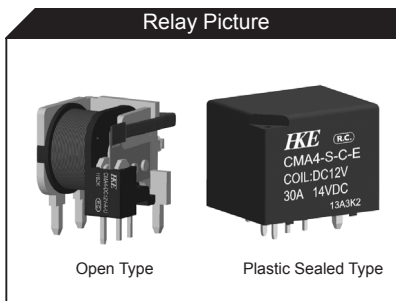

- ### Features
- General purpose automotive relay
Available in open frame and plastic sealed packages
Sealed: 25.8×20.6×21.0(mm)
Open: 18.0×23.4×17.9(mm)
 - High contact capacity 40A
 - USA or European footprints



ORDERING INFORMATION

CMA4 - S - DC12V - A - E

Model	Enclosure	Coil Voltage	Contact Form	Footprint
	S - Plastic Sealed Type Blank-Open Type	DC6V, DC9V, DC12V, DC24V	A - 1 Form A C - 1 Form C	E - European footprint U - USA footprint

SPECIFICATION

CONTACT DATA

Contact Form	1 Form A, 1 Form C	
Contact Material	Ag Alloy	
Contact Rating	30A 14VDC Resistive (C) 40A 14VDC Resistive (A)	
Contact Resistance	Max. 100mΩ (6VDC 1A)	
Load	Max. Switching Voltage	75VDC
	Max. Switching Current	Refer to table1
	Max. Switching Power	560W
Life	Electrical	100,000 operations
	Mechanical	10,000,000 operations

COIL DATA

Nominal Coil Power	1.6W
--------------------	------

GENERAL DATA

Insulation Resistance	Min. 100MΩ 500VDC	
Dielectric Strength	Between open contacts	550VAC, 1min
	Between coil and contacts	550VAC, 1min
Operate Time	Max. 5ms	
Release Time	Max. 3ms	
Operating Temperature	-40°C to +85°C	
Humidity	35~95%RH, +40°C	
Shock Resistance	Endurance	1,000m/s ²
	Misoperation	100m/s ²
Vibration Resistance	Endurance	10~55Hz, 1.5mm double amplitude
	Misoperation	10~55Hz, 1.5mm double amplitude
Weight	Approximately 21.0g (Plastic Sealed Type) Approximately 15.0g (Open Type)	

Note:Data shown are of initial value

Table 1 (Maximum Switching Current)

Load	1 Form A	1 Form C	
		NO	NC
Contact Rating Current	40A	40A	30A
Max.Make Current	100A	100A	30A
Max.Break Current	40A	40A	30A

COIL DATA

Ambient Temperature: 23°C

Model	Nominal Voltage VDC	Coil Resistance $\Omega \pm 10\%$	Operate Voltage \leq VDC	Release Voltage \geq VDC	Coil Power W
CMA4-(S)-DC6V	6	22.5	3.6	0.6	1.6
CMA4-(S)-DC9V	9	51.0	5.4	0.9	
CMA4-(S)-DC12V	12	90.0	7.2	1.2	
CMA4-(S)-DC24V	24	360	14.4	2.4	

OUTLINE, WIRING DIAGRAM, MOUNTING HOLE LAYOUT (UNIT: mm)

Plastic Sealed Type
(European footprint)

Outline

Mounting Hole Layout
(Bottom View)

European footprint (11mm)

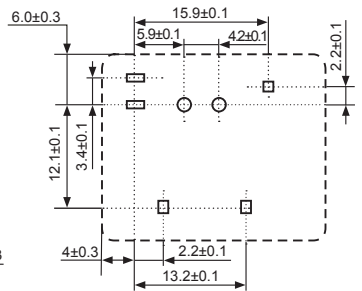
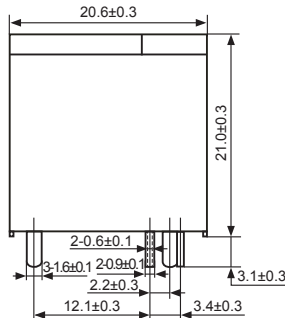
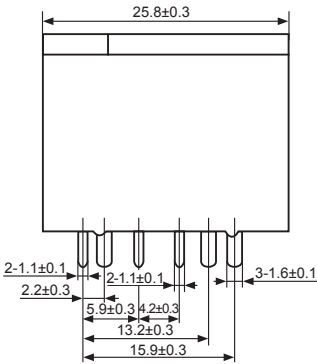

Plastic Sealed Type
(USA footprint)

Outline

Mounting Hole Layout
(Bottom View)

USA footprint (8mm)

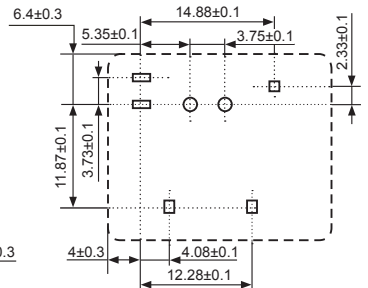
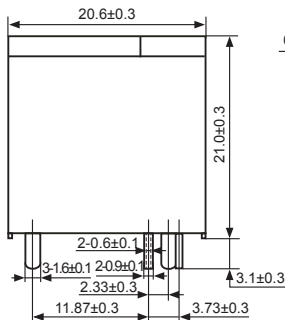
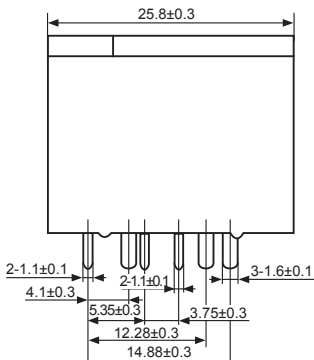

OUTLINE, WIRING DIAGRAM, MOUNTING HOLE LAYOUT (UNIT: mm)

Open Type
(European footprint)

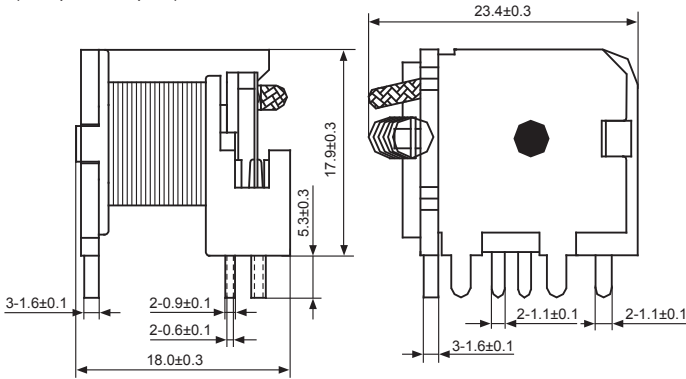

Mounting Hole Layout
(Bottom View)

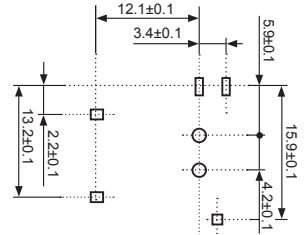

Open Type
(USA footprint)

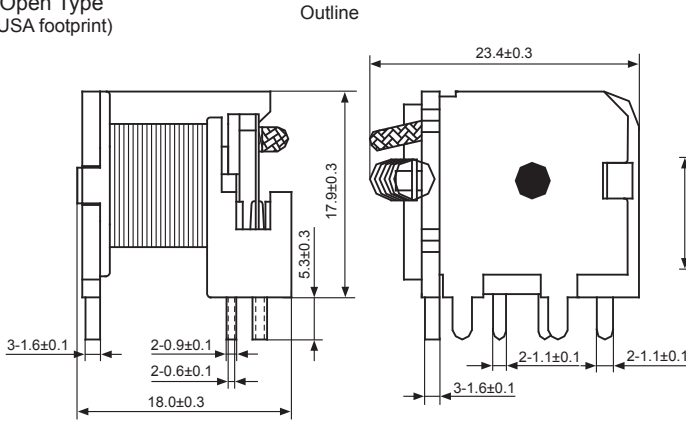

Mounting Hole Layout
(Bottom View)

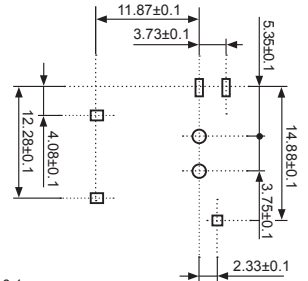

Wiring Diagram
(Bottom View)

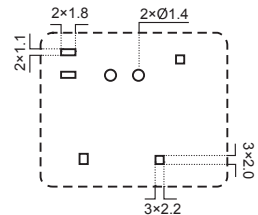
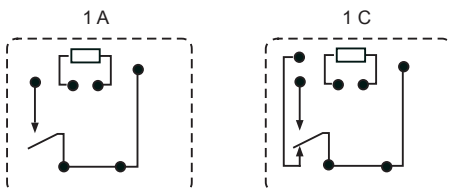

REFERENCE DATA

Limiting Curve for Power Load

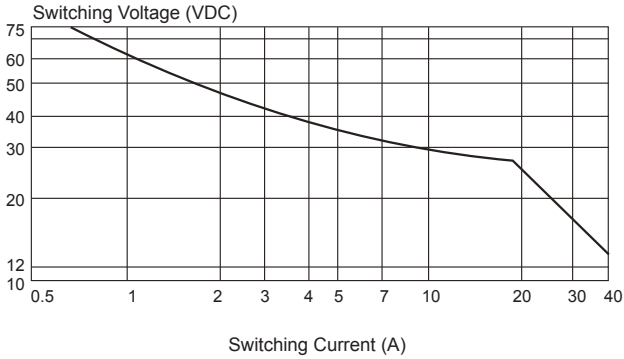

Ambient Temperature vs. Coil Voltage for Continuous Duty

